

Large-scale test on geosynthetic reinforced unpaved roads on soft subgrade.

N.Khoueiry, GEOMAS, Université de Lyon, INSA Lyon, France
L.Briançon, GEOMAS, Université de Lyon, INSA Lyon, France
A.Daouadji, GEOMAS, Université de Lyon, INSA Lyon, France
M.Riot, AFITEXINOV, Saint Didier de la Tour, France

ABSTRACT

Geosynthetics have been widely used since 1970 in unpaved roads. Various research studies showed the benefits of the reinforcement in facilitating the fill material compaction, improving the platform bearing capacity, which will allow the reduction of the fill material thickness, and the increase of the structure serviceability term. Different mechanisms take place between the aggregates platform and the reinforcement. Which affect the structural behavior: the aggregates platform confinement, the separation between the weak subgrade and the fill material, the membrane effect. The road structure becomes even more heterogeneous and the mechanisms more complex with the addition of the reinforcement layer and the underlying mechanics are still not completely understood. Therefore, it is important to provide more knowledge regarding these mechanisms, in order to propose an efficient design method for such structure.

A full-scale laboratory test on unpaved roads has been designed and developed to characterize the effect of the reinforcement in this application. The platform tested is placed in a large box of 5 m in length, 1.9 m in width and 1.4 m in height. The tested platform is composed of 60 cm of weak subgrade supporting 22 cm or 35 cm of well-compacted fill material. A special attention has been given to the soil layers preparation, installation and quality control. The tested structure was subjected to a cyclic plate load and to a circulation traffic load using a large-scale apparatus SAT (Simulator Accelerator of Traffic). This apparatus was developed and adapted for this flexible structure. Indeed, it allows the application of a heavy traffic load on the unpaved road surface even for large surface displacement. During each test, the rut development, the vertical stress distribution and the settlement in the subgrade soil are monitored.

In the present paper, the results of the cyclic plate loading tests are presented. In fact, six tests were performed, two reinforced and unreinforced platforms with 35 cm of base course thickness, and four reinforced and unreinforced tests with 22 cm of base course thickness.

The results are presented in terms of vertical stress distribution on the subgrade surface, and vertical stress and ruts evolution with cycles. The results allowed the verification of the experimental protocol repeatability. Moreover, the comparison between the reinforced and unreinforced platform with different base course thicknesses. In fact, the results of these first tests allowed the protocol preparation for further tests using the SAT apparatus.

Keywords: Geosynthetics, unpaved roads, soil reinforcement, large-scale test, Subgrade

1. INTRODUCTION

Unpaved roads are structures composed of a subgrade layer and an unbounded gravel layer. The circulation on a soft subgrade results in an excessive rut development. The traditional solution for this problem is the replacement of the subgrade layer with a thick base course layer. However, this solution is far from being an economic solution. Therefore, the geosynthetics are often used in this application. In fact, the use of geosynthetics in the reinforcement of the base course layer increases the platform bearing capacity, the platform serviceability term and allows the base course layer thickness reduction. Different and complex mechanisms are developed in the reinforced platform: the aggregates lateral restraint, the tension membrane and the separation mechanism.

The addition of the reinforcement layer at the base course bottom blocks the lateral movement of the aggregates under the vertical loading. This phenomena results in the increase of the base course stiffness and the base course stress distribution angle. It is important to note that the geosynthetic blocks the lateral aggregates movement by two different mechanisms depending on the geosynthetic type: the interlocking between the aggregates and the geosynthetic apertures, when it is a geogrid, and the friction, when it is a geotextile.

The tension developed in a curved geosynthetic results in an upward force, which helps decreasing the distribution vertical stress on the subgrade. It was noted in the literature that this mechanism is predominant for significant rut development Perkins & Ismeik (1997).

The separation between the subgrade layer and the aggregates prevent the loss of the base course properties during the circulation due to the mixing between both layers. This function is normally insured by a geotextile. However Giroud (2009) mentioned that a geogrid with appropriate aperture size can also provide the separation function.

As seen above, these mechanisms take place at the interface, and the influence of one mechanism depends on different properties and criterias as the geosynthetic type, the position, the ribs stiffness, the node stability factor, the apertures size and shape, the base course properties, the base course thickness and the subgrade properties.

Various experimental tests were proposed in the literature in order to provide knowledge regarding the mechanisms developed at the interface and the influence of the involved parameters.

Palmeira & Antunes (2010), Qian et al. (2011 and 2013), Sun et al. (2015) and Kim et al. (2006) proposed a cyclic plate load test in the laboratory on reinforced and unreinforced platforms. The results of these experimental tests were used to compare the effect of different Geosynthetic types and evaluate the reinforcement effect. However, the loading conditions used in this protocol do not simulate perfectly the real trafficking conditions on site.

Hufenus et al. (2006), Cuelho & Perkins (2009) and Cuelho et al. (2014) performed full-scale in-situ tests. The authors constituted an in situ testing sections and used a truck to apply the load. The load application simulates the real application. However, the number of passes is limited since it is a manual load application. Moreover, since it is an outdoor test it makes the soil conditions hard to control.

To avoid the in-situ tests inconvenient, the full-scale Accelerated Pavement Testing (f-sAPT) facilities were used. These facilities allow the application of an automatic traffic load, with various load intensity, circulation velocity, and load direction. More importantly, these facilities are usually placed in a big hangar so the soil properties can be controlled and independent from the weather conditions. The f-sAPT were used over the years to provide knowledge regarding the response of a prototype or actual pavement system under a controlled accelerated traffic load.

In the literature, many authors used the f-sAPT facilities to test the effect of the reinforcement in the unpaved roads.

Watts et al. (2004) et Cook et al. (2016) used the Transport Research Laboratory (TRL) pavement test facility to characterise the response of the tested platforms. Cook et al. (2016) performed eight tests, in each test the platform was divided in different sections with different reinforcement types and configurations. A bi-directional traffic load was applied with a load intensity of 40 kN and a velocity of 15 km/h. based on the results the authors noted the important contribution of the confinement mechanism. Watts et al. (2004) performed tests following the same protocol but with different geosynthetic types. The authors compared the experimental results to the Giroud and Noiray (1981) design method, and concluded that the calculated base course thickness was overly conservative in some cases.

Jersey et al. (2012), Norwood & Tingle (2014) and Robinson et al. (2017) performed f-sAPT tests using the U.S. Army Corps of Engineers facility. The pit was divided in 5 different test sections. It is worth pointing out that the used reinforcement products in these research programmes have a specific manufacturing process. However, based on the results the authors highlighted the benefit of these specific products in increasing the platform bearing capacity.

Yang et al. (2012) used the Accelerated Pavement Testing (APT) facility at Kansas State University to test the geocell efficiency in this application. The pit was divided in four different sections with different geocell types. Based on the results the authors proved the efficiency of the geocell in this application regarding the rut development at the surface.

As mentioned before, the limitation of the in-situ tests are the properties control and the limited number of passes. The f-sAPT facilities were used to avoid the in-situ limitations. However, the facilities used in the literature for this application, are facilities designed to test the pavement layers. Therefore, large pits are used, and this applies large installation works in the case of deep layers testing. In the presented work, an f-sAPT was developed at INSA Lyon especially for the unpaved road application. The main purpose was to optimise the dimensions and the installation work. However, two loading tests were performed on the same prepared platform: the plate and the circulation cyclic load. This allows the comparison between the most used loading system for this application (the plate load test) and the circulation loading system, which is the most realistic loading. In this paper, the results are reduced to the results of the cyclic plate load test. In fact, a reference unreinforced platform and a reinforced platform were tested with different base course thicknesses. The results of these tests were used to verify the developed protocol and prepare the circulation load tests using the SAT apparatus.

2. EXPERIMENTAL DEVICE

The SAT apparatus was developed at INSA Lyon especially for this application. As mentioned before the main aim of this apparatus was the optimisation of the platform dimensions. This apparatus applies the load under constant velocity on an effective length of 2m far from the contact impact zones.

Moreover, since we are dealing with high rut development at the surface, the challenge was to keep the contact between the wheel and the platform surface with the same load magnitude even after excessive rut development. Therefore a special mechanical concept was developed. In fact, the SAT applies the load under its own weight, and the air pneumatic jacks adjust the load in order to have the required load. The central beam is attached to a deformable parallelogram in order to apply the same load magnitude at every tear position, and to apply the same load even after high surface deformation. Moreover, the air pneumatic jacks can control the load in order to apply unidirectional traffic load, this option can be deactivated so a bidirectional load can be applied. Two chains carry the tire axle movement, and are connected to an electrical motor that controls the movement. The overall weight of the apparatus is 8400 kg. The apparatus reduced dimensions and weight facilitate the mobility of the machine in the laboratory or even on site. The SAT can apply load on a platform placed in a geotechnical box on a specific altitude, or even apply load on a zero altitude platform, and this is due to its adjustable support.

The applied load magnitude, the velocity, and the number of cycles can be adjusted depending on the application. The load is applied on a single filled tire, but the tire can change depending on the application.

In this application the load applied on the surface is equal to 40 kN, with a resulted pressure at the contact area of 566 kPa based on the AASHTO(1993) standard. The unpaved roads are designed to support 10000 cycles with an allowable maximum displacement of 75 mm regarding the FHWA(2008) standard. The circulation velocity is around 7km/h.

A hydraulic jack applies the cyclic plate load on a plate with 30 cm of diameter. Same as the circulation load the maximum applied load is equal 40 kN resulting in a applied pressure of 566 kPa. The maximum load was maintained for 0.2 second, the unload phase was maintained for 0.5 sec, and the loading-unloading phase was done in 0.6 sec.

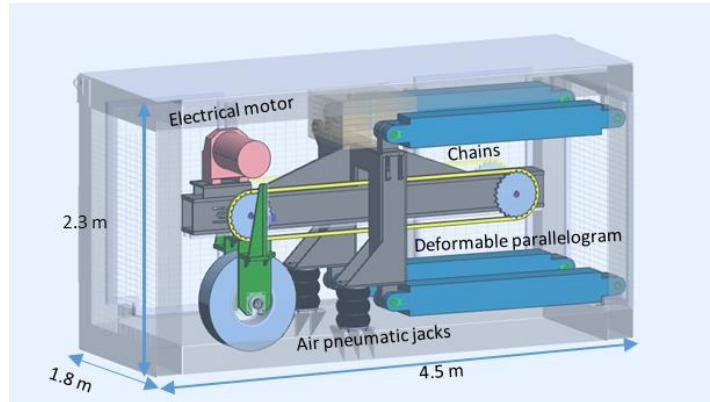

(b)

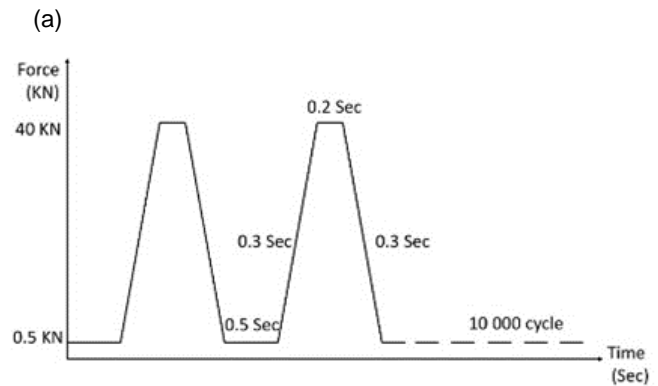

(c)

Figure 1: (a)The Simulator Accelerator of Traffic (SAT), (b) The hydraulic jack for the plate load test, (c) The cyclic load diagram applied on the plate.

3. PLATFORM MATERIALS

The tested platform is placed in a box: 5 m of length and 1.9 m of width and 1.4 m of height. 3 m of the length are subjected to the circulation load with the SAT apparatus, and the other 2 m are subjected to the cyclic plate load.

60 cm of soft subgrade are placed at the box bottom and this layer support 22 cm or 35 cm of base course. The reinforcement is placed at the interface between the subgrade and the base course.

3.1 Subgrade

In order to constitute for each test the same subgrade with the same properties, an artificial soil was constituted: A mixture of sand and clay: 20% of Kaolinite clay and 80% of Hostun sand. The criteria of the subgrade is a CBR<3% regarding the FHWA (2008) standard.

Based on the Proctor and CBR curves the subgrade should be compacted at 11.5% of water content in order to have a CBR of 2%.

3.2 Base course

The aggregates used in these tests is a non-treated aggregates (GNT 0/31.5), which is the most used material for this application in France. This soil is classified as a GP (poorly graded gravel) soil regarding the USCS standard. Based on the Proctor and CBR curves the base course should be compacted with a water content of 4% to reach the maximum Proctor dry density of 21.5 kN/m³.

3.3 Geosynthetic

A layer of light woven geotextile (17 g/m²) was placed under the geogrid layer in order to reduce the subgrade pollution. The GSY used in the presented paper is a coated geogrid.

Table 1: The geogrid properties.

Name	Type	Nature	Stiffness at 2 % (kN/m)	Aperture	Maximum tensile strength (kN/m)	
					SP*	ST*
GSY 1	NotexC PET	PET	1000	40	100	100

4. INSTRUMENTATION

The aim of this experimental protocol is the characterisation of the GSY effect in this application. Therefore, the vertical stress distribution in the subgrade, the subgrade surface settlement and the rut development with the cycles are monitored. EPC (Earth Pressure Cell): it is an electrical pressure cell used to monitor the soil vertical stress, with 10 cm of width and 20 cm of length, and a measurement range between 0 and 500 kPa.

S (Settlement sensors): it is a hydraulic settlement sensor, with 6.2 cm of height and 5 cm of diameter, and a measurement range between 0 and 30 cm.

Displacement sensor: it is a laser sensor with a measurement range between 20 and 700 cm.

The same instrumentation configuration was placed under the plate loading and under the circulation loading. Five EPC were placed at the subgrade surface, one sensor placed at the platform centre under the load centre, and four sensors placed at a distance of 10 cm, 20 cm, 40 cm, 60 cm from the centred sensor. Moreover, 3 sensors were placed at the subgrade centre at different depth positions: 20 cm, 40 cm at 60 cm from the subgrade surface.

The settlement sensors are placed at the subgrade surface at the same positions as the EPCs.

5. TESTS

As mentioned before in this paper the results of six tests performed using the cyclic plate loading facility are presented:

Table 2: Performed tests details.

Test number	Base course thickness (cm)	Reinforcement	Test status
Test 1	35	Without reinforcement	Reference test
Test 2	35	GSY1	GSY improvement test
Test 3	22	Without reinforcement	Reference test
Test 4	22	Without reinforcement	Repeatability test
Test 5	22	GSY 1	GSY improvement test
Test 6	22	GSY 1	Repeatability test

6. TEST SETUP AND QUALITY CONTROL TESTS

As mentioned before the subgrade mixture should be compacted with a water content of 11.5% to get a CBR of 2%. A series of installation protocol were tested in order to setup an installation protocol that results in a homogeneous layer with a CBR of 2%. This protocol consists of compacting the first 30 cm with one compactor pass, then 2 layers of 10 cm with one compactor pass each, and placing the last 10 cm without any compaction since it will be subjected to the aggregates compaction. The aggregates layer should be compacted with a water content of 4% to reach the maximum proctor. The final installation Protocol adopted consists of placing two layers of 11 cm and compact each layer with four compactor passes.

In order to compare the effect of different GSYs reinforcement using these test facilities the prepared platform layers for each test should present the same properties. Therefore, a series of quality control tests were performed on each soil layer prepared for testing. These tests consist of a water content profile, a shear vane test, a static penetrometer test and a dynamic penetrometer test. The results of the static and dynamic penetrometer tests were correlated to the CBR values.

The water content profile along the subgrade depth was plotted before and after each test, in order to make sure that the water content does not change during the test, and that there are no water migration during the test. The results of the water content profile shows that the water content remains constant over the depth and during the test.

The shear vane test was used as a comparison values over the subgrade depth to verify the layer homogeneity.

The static penetrometer was performed in the subgrade using the CBR cone, and the results were correlated to the CBR using the apparatus technical sheet.

Moreover, the dynamic penetrometer test was performed in the subgrade and the base course layer, the Kleyn and Van Heerden formula was used to correlate the results to the CBR based on the apparatus technical sheet:

$$\text{Log}_{10} (\text{CBR}) = 2.632 - 1.28 \text{Log}_{10} (\text{DCP}) \quad [1]$$

Figure 2 shows the dynamic penetrometer tests correlated results. The curves superposition confirms the soil preparation repeatability for the different performed tests. In fact, this superposition conforms the installation and compaction protocol presented above. It is shown in the graph that the base course CBR near the surface is less than 5 %, this is due to the surface soil repulsion. However, more in depth the base course CBR varies between 10 and 15 %, it reaches 20 % at some points. More in depth, the graph shows a homogeneous layer presenting a CBR of 2 %.

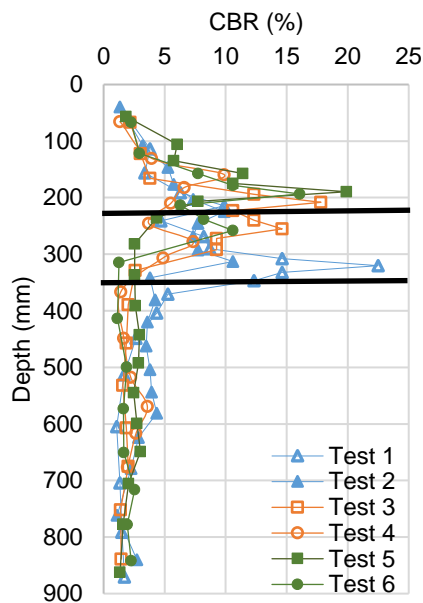

Figure 2: CBR profile based on the dynamic penetrometer quality control tests.

7. RESULTS

As mentioned before the aim of this experimental protocol is the quantification of the reinforcement improvement in this application. Five platforms were tested and presented in this paper. A reinforced and unreinforced platform with a base course thickness of 35 cm. The results of these first tests showed no reinforcement significant effect. In fact it is shown in Figure 3, the final settlement profiles at the base course surface for both reinforced (test 2) and unreinforced (test 1) 35 cm of base course tests are relatively superposed. In fact, the maximum rut developed after 10000 cycles is around 45 mm for the unreinforced platform and around 50 mm for the reinforced platform. Therefore, we supposed that the reinforcement effect is negligible in the case of 35 cm of base course thickness and we performed further tests with a base course thickness of 22 cm. Two identical unreinforcement (test 3 and 4) and two reinforced identical tests (test 5 and 6) were performed in order to verify the test repeatability.

It is important pointing out the symmetrical settlement profile shown in Figure 3. Moreover, the superposition of the settlement profile of the two identical tests shows the repeatability of the test. In fact, the identical unreinforced platforms show identical settlement profiles with an average maximum rut development of 90 mm. Moreover, the identical reinforced platforms show identical settlement profiles with an average maximum rut development of 70 mm. Beside the test repeatability, these results show the reinforcement effect in reducing the rut development at the surface. In fact, the reinforcement reduced the rut development of about 22 %. More importantly, the unreinforced platform reached the design ultimate allowable rut of 75 mm after 300 cycles, but the reinforced platform reaches that value after 9000 cycles (Figure 4). This shows the reinforcement effect in increasing the platform serviceability term.

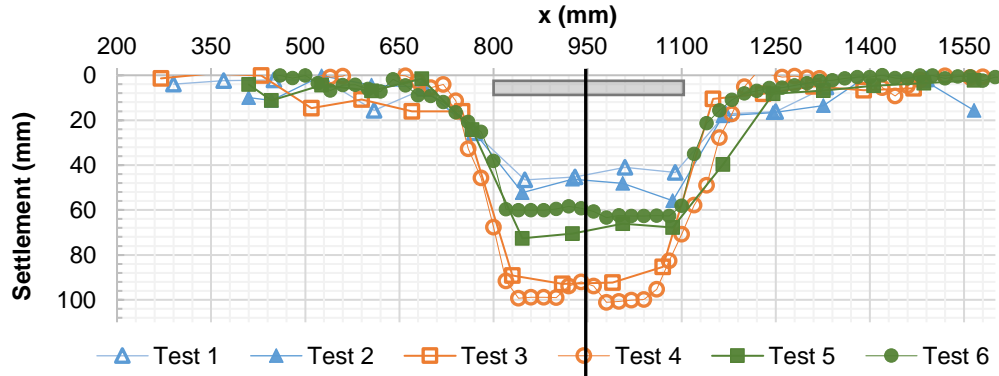

Figure 3: The settlement profile at the base course surface.

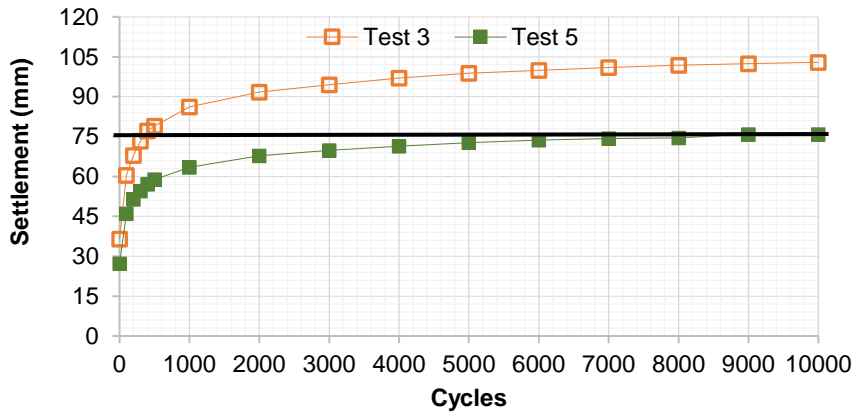
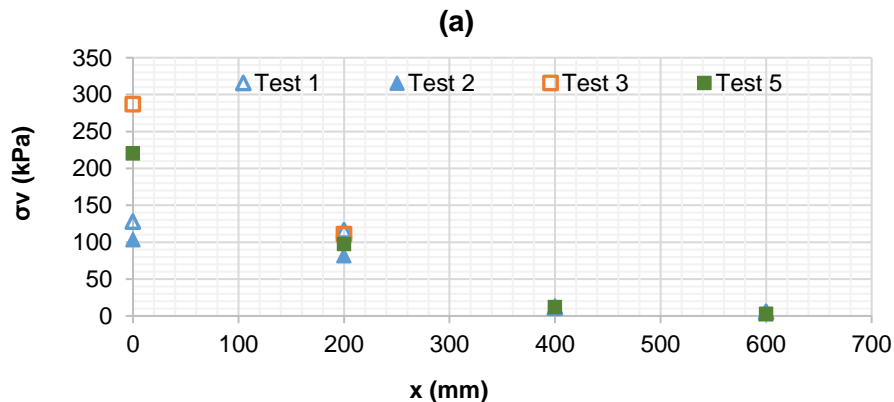

Figure 4: The settlement evolution with cycles at the base course surface centre for H=22cm.

The earth pressure cells placed at different positions from the surface centre measured the vertical stress at the subgrade. The stress distribution curves are illustrated in Figure 5, after 500 cycles (a) and 10000 cycles (b). By comparing the results of the reinforced and unreinforced platform with 22 cm of base course, the figure shows an important influence of the reinforcement on the maximum stress at the subgrade centre. In fact, after 500 cycles the stress decreases from 290 kPa without reinforcement to 220 kPa with reinforcement. Moreover, after 10000 cycles the stress decreases from 296 kPa without reinforcement to 246 kPa with reinforcement, which is a drop of 17%.

This stress reduction can be due to the increase in the base course stiffness with the reinforcement implementation at the interface, or due to the upward resultant force due to the tension membrane effect. However, it is worth pointing out the significant reduction of the stress due to the 13 cm of base course added between the unreinforced 22 cm of base course and 35 cm. In fact, Figure 4 shows that the central vertical stress decrease from 290 kPa with 22 cm of base course to 120 kPa with 35 cm of base course, which is a drop of 60 %.



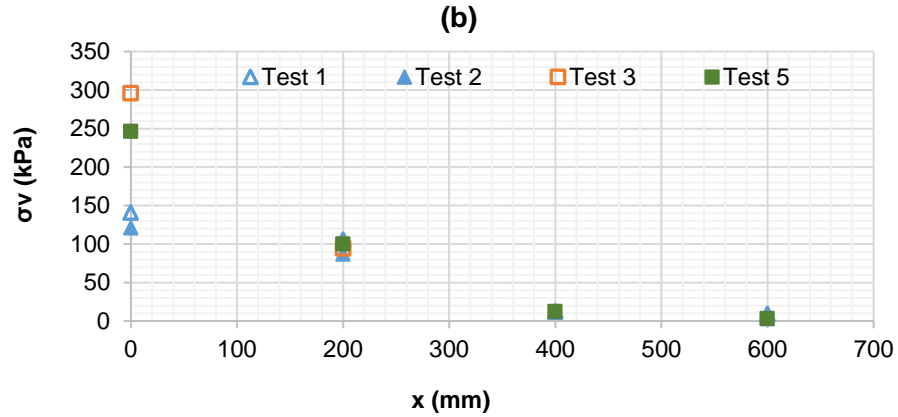

Figure 4: The vertical stress distribution at the subgrade surface, (a) after 500 cycles, (b) after 10000 cycles.

As seen above, the reinforcement increases the structure serviceability life by reducing the excessive surface developed rut, and reduces the vertical stress developed at the centre of the subgrade surface. In order to highlight the benefit of the reinforcement the traffic benefit ratio (TBR) was calculated, at 45 mm, 60 mm and 75 mm of surface rutting:

$$TBR = \frac{N_{reinforced}}{N_{unreinforced}} \quad [2]$$

Where $N_{reinforced}$ is equal the number of load cycles for the reinforced platform at a certain permanent deformation and $N_{unreinforced}$ is equal the number of load cycles for the unreinforced platform at the same permanent deformation.

Figure 5 presents the vertical stress at the subgrade centre for both reinforced and unreinforced platform at different settlement levels. Moreover, it represents the TBR values at the same settlement levels.

This figure shows the increase of the maximum vertical stress at the subgrade centre with the rutting development in the case of the reinforced platform. More importantly, the figure shows the increase of the TBR value with the increase of the allowable rut criteria. In fact, for 45 mm, the TBR is equal to two, for 60 mm the TBE is equal 7.5 and for 75 mm the TBR is equal 26. This shows that the efficiency of the reinforcement is more important for high rut development.

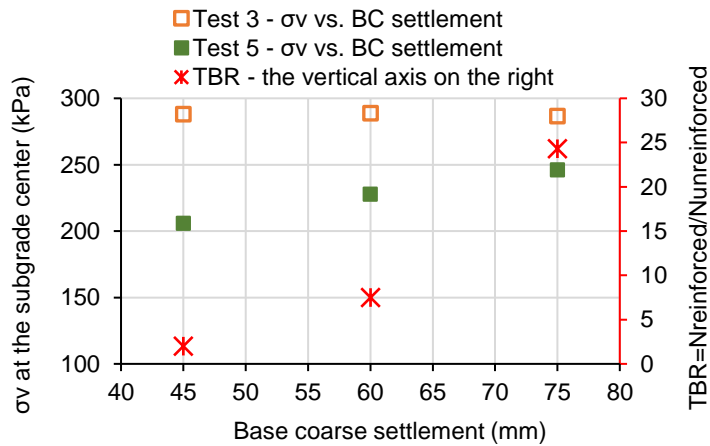

Figure 5: the maximum vertical stress at the subgrade surface and TBR for specific base course settlement (45-60-75 mm).

8. CONCLUSIONS

The aim of this research work is to develop an experimental protocol to test the GSY reinforcement in unpaved roads on soft subgrade application. The test consisted of applying two load types on the prepared platform: a cyclic plate load and a circulation traffic load using the developed machine SAT. A special attention was given to the platform preparation in order to have a repeatable protocol.

In this paper, we presented the all preparation protocol and the platform quality control tests. Moreover, the results of the tests performed under the cyclic plat loading.

The surface rutting, the subgrade surface settlement and the vertical stress developed at the subgrade surface are monitored during the cycles.

The results of six tests were presented above a reinforced and unreinforced platform with 35 cm of base course thickness, two reinforced and unreinforced platforms with 22 cm of base course thickness. The reinforced and unreinforced results performed on the platform with 35 cm shows a negligible reinforcement effect for a thick platform.

Moreover, the results of the two identical reinforced and unreinforced platform with 22 cm of base course proved the repeatability of the test and especially the platform preparation and quality control protocol. In fact, the identical tests give similar results.

In addition, the comparison between the reinforced and unreinforced platform with 22 cm of base course shows the benefit of the GSY reinforcement. In fact, the reinforcement reduced the maximum vertical stress developed at the subgrade surface of 22%, and the rut development at the base course surface of 17%. Moreover, the TBR values analysis showed that the reinforcement improvement effect is more important for high allowable rutting criterias.

However, these results presented are limited to the specific GSY type used in these tests.

These first tests using the developed experimental protocol, allowed the verification of the protocol procedure and reliability. Further tests using both the cyclic load tests and the SAT apparatus and other GSY types are planned.

9. ACKNOWLEDGEMENT

This study was performed in the framework of the new French Laboratory of Technical Innovations applied to Reinforcement GSYs (PITAGOR) funded in December 2015 by the French National Research Agency. The authors would like to thank the French National Research Agency that made this experimental study possible.

10. REFERENCES

Cook, J., Dobie, M., & Blackman, D. (2016). *The development of APT methodology in the application and derivation of geosynthetic benefits in roadway design*. In *The Roles of Accelerated Pavement Testing in Pavement Sustainability* (pp. 257-275).

Giroud, J. P. (2009). *An assessment of the use of geogrids in unpaved roads and unpaved areas*. In *Jubilee Symposium on Polymer Geogrid Reinforcement. Identifying the Direction of Future Research*, ICE, London, 8th September.

Giroud, J. P., & Noiray, L. (1981). *Geotextile-reinforced unpaved road design*. *Journal of Geotechnical and Geoenvironmental Engineering*, 107 (ASCE 16489).

Hufenus, R., Rueegger, R., Banjac, R., Mayor, P., Springman, S. M., & Brönnimann, R. (2006). *Full-scale field tests on geosynthetic reinforced unpaved roads on soft subgrade*. *Geotextiles and Geomembranes*, 24(1), 21-37.

Kim, W. H., Edil, T. B., Benson, C. H., & Tanyu, B. F. (2006). *Deflection of prototype geosynthetic-reinforced working platforms over soft subgrade*. *Transportation research record*, 1975(1), 137-145.

Palmeira, E. M., & Antunes, L. G. (2010). *Large scale tests on geosynthetic reinforced unpaved roads subjected to surface maintenance*. *Geotextiles and Geomembranes*, 28(6), 547-558.

Perkins, S. W., & Ismeik, M. (1997). *A Synthesis and Evaluation of Geosynthetic-Reinforced Base Layers in Flexible Pavements-Part I*. *Geosynthetics International*, 4(6), 549-604.

Qian, Y., Han, J., Pokharel, S. K., & Parsons, R. L. (2011). *Stress analysis on triangular-aperture geogrid-reinforced bases over weak subgrade under cyclic loading: An experimental study*. *Transportation Research Record*, 2204(1), 83-91.

Qian, Y., Han, J., Pokharel, S. K., & Parsons, R. L. (2012). *Performance of triangular aperture geogrid-reinforced base courses over weak subgrade under cyclic loading*. *Journal of Materials in Civil Engineering*, 25(8), 1013-1021.

Robinson, W. J., Tingle, J. S., & Norwood, G. J. (2017). *Full-Scale Accelerated Testing of Multi-axial Geogrid Stabilized Flexible Pavements (No. ERDC/GSL TR-17-9)*. ERDC-GSL vicksburg United States.

Sun, X., Han, J., Kwon, J., Parsons, R. L., & Wayne, M. H. (2015). *Radial stresses and resilient deformations of geogrid-stabilized unpaved roads under cyclic plate loading tests*. *Geotextiles and Geomembranes*, 43(5), 440-449.

Watts, G. R. A., Blackman, D. I., & Jenner, C. G. (2004). *The performance of reinforced unpaved sub-bases subjected to trafficking*.

Yang, X., Han, J., Pokharel, S. K., Manandhar, C., Parsons, R. L., Leshchinsky, D., & Halahmi, I. (2012). *Accelerated pavement testing of unpaved roads with geocell-reinforced sand bases*. *Geotextiles and Geomembranes*, 32, 95-103.